

DATA SHEET

S6EXPO050-199

BEAMEXPANDER
MAGNIFICATION 5.0
FOR 266 nm
FUSED SILICA



OUTLINE DRAWING

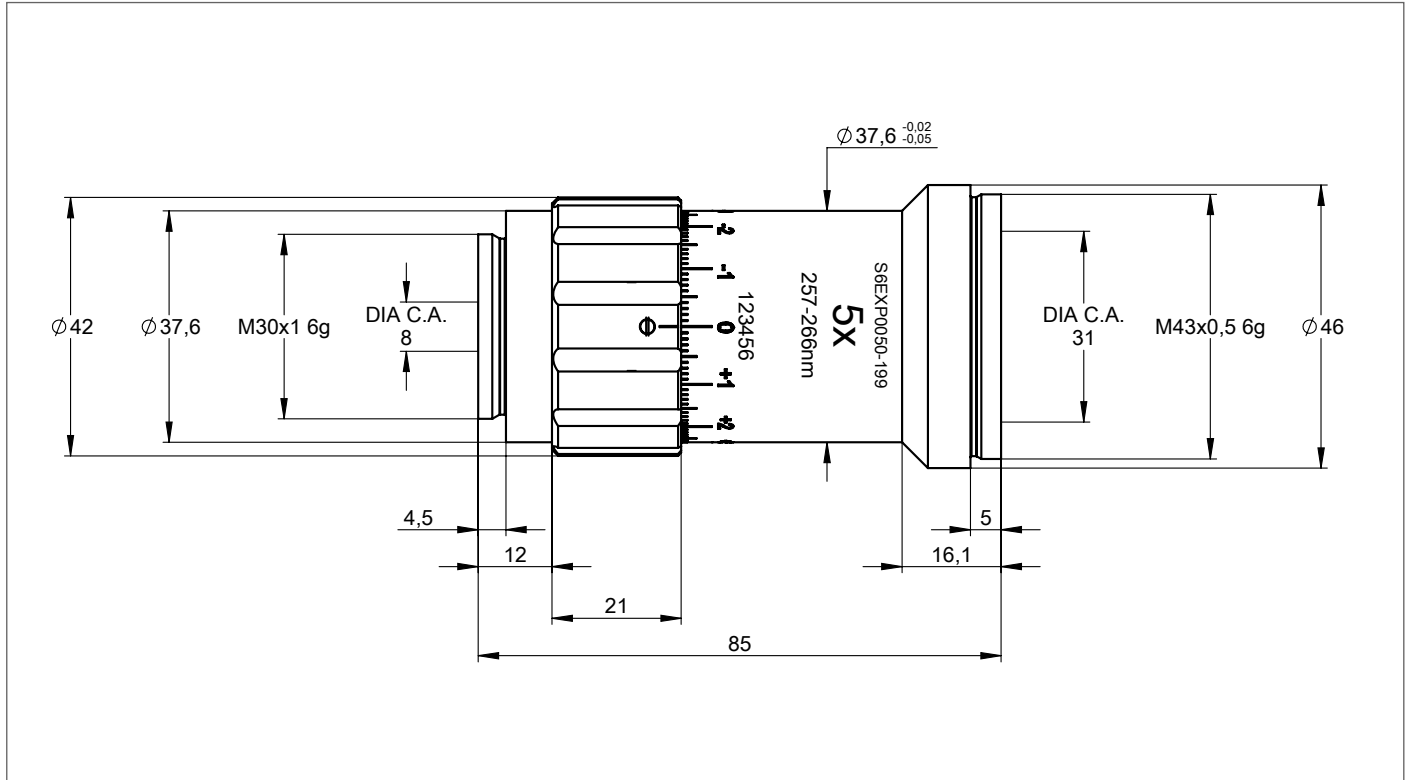

All information contained in this data sheet is for information purposes only and is not binding. The content is subject to change at any time without notification, all information without guarantee. We reserve the right to make constructional changes in the course of product improvement. Copyright © Sill Optics GmbH • All rights reserved

Sill Optics GmbH • Johann-Höllfritsch-Straße 13 • D-90530 Wendelstein • +49 9129 9023-0 • Published: 4.09.2023

DATA SHEET

SPECIFICATIONS

article number	S6EXP0050-199
design wavelength [nm]	266
magnification factor	5.0
divergence adjustable	yes
optical principle	Galilei (no internal focus)
pointing stability [mrad]	< 1
clear input aperture [mm]	8.0
clear output aperture [mm]	31.0
recommended beam-Ø [mm] ¹⁾	4.5
total number of lenses	3
total transmission [%]	> 98
lens material	fused silica
LIDT (coating) [J/cm ²]	0.5 J/cm ² per 1ns pulse at 50Hz
SP and USP usable	yes
SP and USP usable, reversed usage	no
mounting thread	M30x1
weight [kg]	0.2
accessory	S6MEC0107 - adapter M30x1 to C-mount

DIVERGENCE ADJUSTMENT

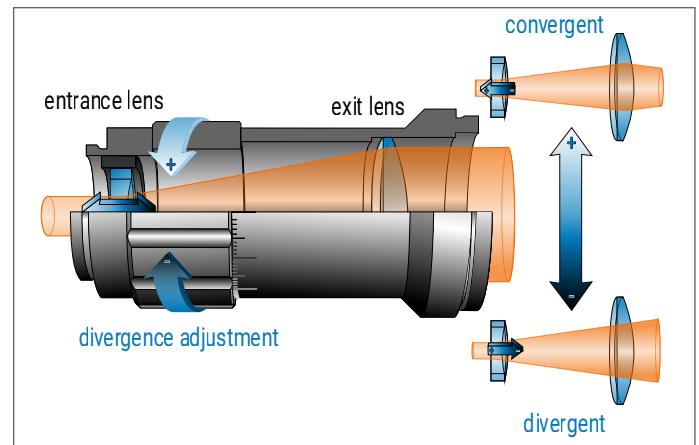

MOUNTING POSITIONS

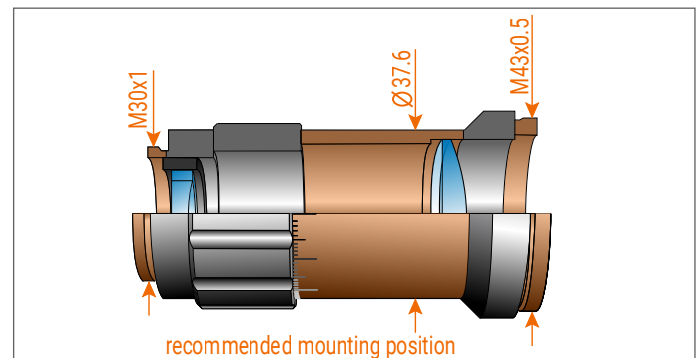

REMARKS

¹⁾clipped at $1/e^2$; wavefront error on axis (PV) < $\lambda/10$ (value provided by design)

magnification (reversed mode) = 1 / magnification (regular mode)

divergence adjustment = 0 → collimated input beam results in collimated output beam

maximum divergence adjustment is ± 3 mm

RoHS compliant

length at divergence setting „0“ stated in the drawing - length extension of max. 3 mm is possible

BACK REFLECTION POSITION

back reflections [mm]	
2.2	
back reflections reverse [mm]	
32.14	
5.66	
0.00	

All information contained in this data sheet is for information purposes only and is not binding. The content is subject to change at any time without notification, all information without guarantee. We reserve the right to make constructional changes in the course of product improvement. Copyright © Sill Optics GmbH · All rights reserved

Sill Optics GmbH · Johann-Höllfritsch-Straße 13 · D-90530 Wendelstein · +49 9129 9023-0 · Published: 4.09.2023